





MIBOXER®
Mi • Light Subordinate New Brand

Please read the instructions carefully before using the controller.

1. Features

The controller is adopted by the most advanced PWM control technology, and has memory function(The light status will keep same as the status before you turn off the light);Wireless and 4G controlled by MiBoxer APP.

-  Support Third Party Voice Control
-  WiFi Wireless Control
-  Smart phone App control
-  Compatible with 2.4GHz RF Remote Controller
-  RGB colors to choose
-  Dimmable Saturation control
-  Color temperature 2700-6500K
-  Timing ON/OFF the lights
-  Group control randomly by APP
-  16 Color Changing modes

WORKS WITH amazon alexa

works with the Google Assistant

WiFi 5 in 1 LED Strip Controller
Model No.: WL5

4. Auto-transmitting Diagram

One strip controller can transmit the signals from the remote control to another controller within 30m, as long as there is a strip controller within 30m, the remote control distance can be limitless.

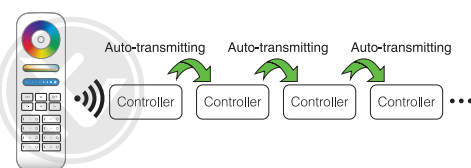

5. Connect to LED strip diagram

Controller input voltage must be in accordance with the required voltage of LED Strips.

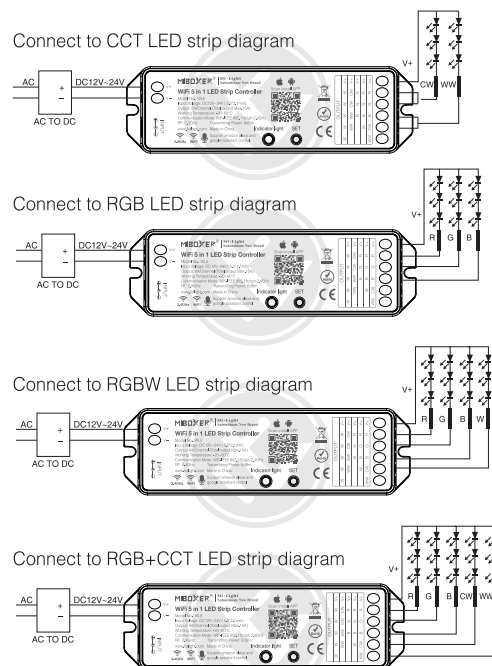

2. Parameters

Model No.: WL5
Input Voltage: DC12V~24V (5.5*2.1mm)
Output: 6A/Channel (Total Output Max.15A)
Working Temperature: -20~60°C
Communication Mode: WiFi-IEEE 802.11b/g/n 2.4GHz
RF: 2.4GHz Transmitting Power: 6dBm
Weight: 65g

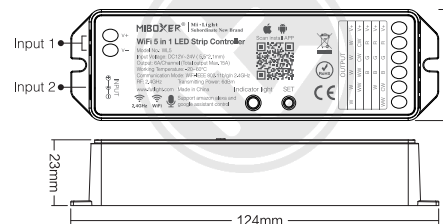

SET Button: Long press "SET" for 3 seconds; When red indicating light blink quickly, device reset and go into Smart Link mode.

Switching Output Mode: Short press "SET" button to switch the output mode; The indicating lamp flickering means switching successfully; Different colors flickering correspond to different output mode; Details see below sheet.

White Light Flickering	Yellow Light Flickering	Red Light Flickering	Green Light Flickering	Blue Light Flickering
Single Color Mode	Dual White Mode	RGB Mode	RGBW Mode	RGB+CCT Mode

6. Remote Controller

Compatible with these remote controls (Purchased separately). For more details, pls read the remote instruction.

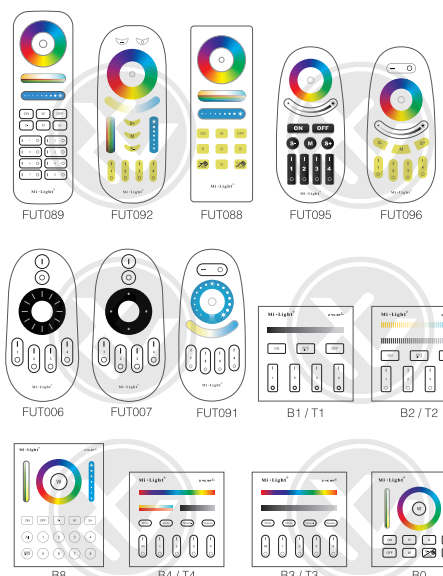

Indicating light instruction:

Red light always-on	Red light blinking	Green light always-on	Green light blinking	Yellow light blinking
Disconnected from network	Smart Link mode	Networking successfully	Received signal	Device malfunction

3. Auto-synchronization function

Different controllers can work synchronously when they are started at different times, controlled by the same remote, under same dynamic mode and with same speed.

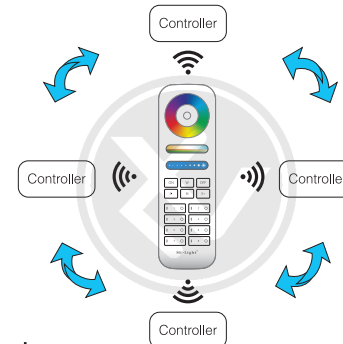

Remark:

- Indicating Auto-transmitting.
- Controller will be auto-synchronizing in the same dynamic modes and within 30m controlling distance.

Attention

- Please check whether the input voltage of the constant voltage power supply is in accordance with the controller, and please check the connection of both the cathode and anode.
- The working Voltage is DC12~24V, the controller will be broken if the voltage is higher than 24V.
- Non-professional user cannot dismantle the controller directly, otherwise, it may cause fire and electric shock.
- The working temperature is -20~60°C; Do not use the device to direct sunlight, moist and other high temperature area.
- Please do not use controller around the mental area and high magnetic field, otherwise, it will badly affect the control distance.

CE, RoHS, WEEE, and other certification logos. Sprzet elektryczny oznaczony symbolem przekreślonego koła nie może być wyrzucany łącznie z odpadami komunalnymi. Taki sprzęt podlega zbiorczej recyklingowi. Piacowska 19, 80-288 Gdańsk, Poland

MiBoxer APP User Instruction

1 APP Downloading

For IOS System: Pls search "MiBoxer" on APP store. (Above IOS9.0)

For Android System: search "MiBoxer" on Google Play (Above Android 5.0) or Scan below QR-code to download APP.



Scan QR Code to Install APP



2 Register MiBoxer Account

Open APP and click Register button; Complete the register and log in.

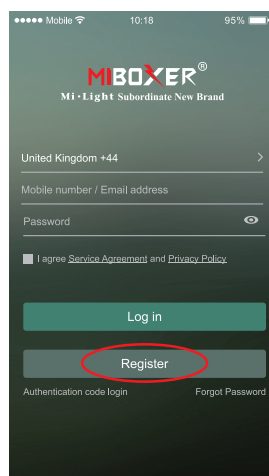

3 Add Device

- Click the right top "+" on the device list.
- Please select the device type you will add, then complete the adding according to the hint of APP.
- Back to device list after adding successfully, then pull down refresh in list to get the device status.

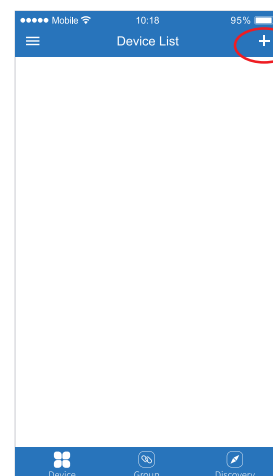

4 Modify device name or delete device

Slide device list to left, click "Edit" to modify device name; click "Delete" to delete device.

Note: If the device was shared to others, then the device will also be deleted on your friends' device list.

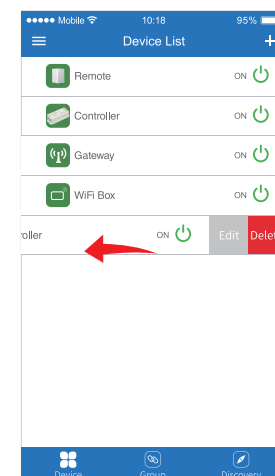

5 Group Control



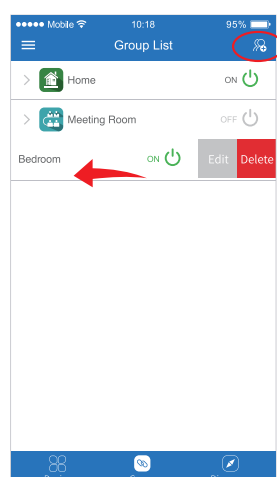

- Click the group icon to switch to Group list, then click the right top group icon on the Group list to create groups.
- Slide the Group list to left to Edit / Delete groups.

Note: The group just work on APP Controlling, cannot work on Voice control. Please open third party APP for Group Voice control.



6 APP Control

Click the device or group that you want to dim on device list and group list into Dimming Interface.

-  Click speed+ under dynamic mode.
-  Click speed- under dynamic mode.
-  Sunset mode: Gradually OFF within 10 minutes.
-  Good night mode: Gradually OFF within 1 minute.

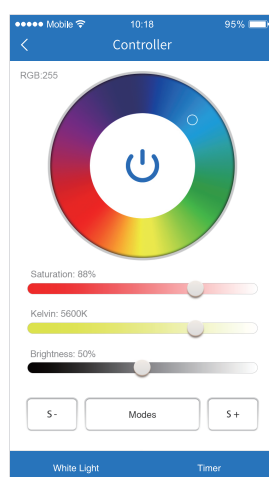

7 Third Party Voice Control instructions

Search "Mi-Light Smart" on third-party platform APP and set up.

Click left top "≡" icon on the home page;

Then click "Voice Control" to check detailed instructions.

WORKS WITH amazon alexa

works with the Google Assistant

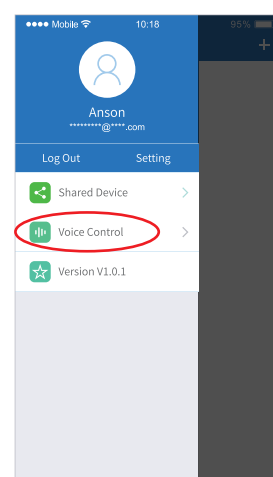

8 Sharing Device

Share the device to friends, Let your friends can control this device.

- Click the left top "≡" icon on the home page.
- Click "Shared Device" to My sharing, then click "Add sharing" (Note: the receiving sharing device cannot be shared again).
- Click "Share" to edit sharing, slide to left to delete sharing.

